

SONY®



PS3™
PlayStation®3

Instruction Manual

Before using this product, carefully read all product documentation and retain it for future reference.

CECH-2501B

4-199-233-12(1)

WARNING

To avoid electrical shock, do not open the cabinet. Refer servicing to qualified personnel only.

Caution

Use of controls or adjustments or performance of procedures other than those specified herein may result in hazardous radiation exposure.

The use of optical instruments with this product will increase eye hazard.

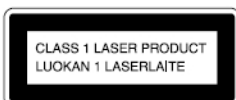

This appliance is classified as a CLASS 1 LASER product under IEC60825-1:2007.

This equipment complies with FCC/IC radiation exposure limits set forth for uncontrolled equipment and meets the FCC radio frequency (RF) Exposure Guidelines in Supplement C to OET65 and RSS-102 of the IC radio frequency (RF) Exposure rules. This equipment should be installed and operated with at least 20 cm (8 in) and more between the radiator and person's body (excluding extremities: hands, wrists, feet and legs).

This transmitter must not be co-located or operated in conjunction with any other antenna or transmitter.

The wireless controller complies with FCC/IC radiation exposure limits set forth for uncontrolled equipment and meets the FCC radio frequency (RF) Exposure Guidelines in Supplement C to OET65 and RSS-102 of the IC radio frequency (RF) Exposure rules. This equipment has very low levels of RF energy that are deemed to comply without testing of specific absorption ratio (SAR).

NOTE:

This equipment has been tested and found to comply with the limits for a Class B digital device, pursuant to Part 15 of the FCC rules. These limits are designed to provide reasonable protection against harmful interference in a residential installation. This equipment generates, uses, and can radiate radio frequency energy and, if not installed and used in accordance with the instructions, may cause harmful interference to radio communications. However, there is no guarantee that interference will not occur in a particular installation. If this equipment does cause harmful interference to radio or television reception, which can be determined by turning the equipment off and on, the user is encouraged to try to correct the interference by one or more of the following measures:

- Reorient or relocate the receiving antenna.
- Increase the separation between the equipment and receiver.
- Connect the equipment into an outlet on a circuit different from that to which the receiver is connected.
- Consult the dealer or an experienced radio/TV technician for help.

You are cautioned that any changes or modifications not expressly approved by the party responsible for compliance could void the user's authority to operate the equipment.

If you have questions about this product, call our technical support line at 1-800-345-7669 or write to:
Sony Computer Entertainment America
Consumer Services/Technical Support
PO Box 5886, San Mateo, CA 94402-0688 U.S.A.

Declaration of Conformity	
Trade Name :	SONY
Model No. :	CECH-2501B
Responsible Party :	Sony Electronics Inc.
Address :	16530 Via Esprillo San Diego, CA 92127 U.S.A.
Telephone No. :	858-942-2230
This device complies with Part 15 of the FCC Rules and RSS-Gen of IC Rules. Operation is subject to the following two conditions: (1) this device may not cause harmful interference, and (2) this device must accept any interference received, including interference that may cause undesired operation of this device.	

About the lithium coin memory back-up battery

The lithium coin memory back-up battery inside this product contains Perchlorate. The following statement is required by the State of California, USA:

Perchlorate Material - special handling may apply. See <http://www.dtsc.ca.gov/hazardouswaste/perchlorate>

Photosensitivity/Epilepsy/Seizures

A very small percentage of individuals may experience epileptic seizures or blackouts when exposed to certain light patterns or flashing lights. Exposure to certain patterns or backgrounds on a television screen or when playing video games may trigger epileptic seizures or blackouts in these individuals. These conditions may trigger previously undetected epileptic symptoms or seizures in persons who have no history of prior seizures or epilepsy. If you, or anyone in your family, has an epileptic condition or has had seizures of any kind, consult your physician before playing.

IMMEDIATELY DISCONTINUE use and consult your physician before resuming gameplay if you or your child experience any of the following health problems or symptoms:

- dizziness,
- altered vision,
- eye or muscle twitches,
- loss of awareness,
- disorientation,
- seizures, or
- any involuntary movement or convulsion.

RESUME GAMEPLAY ONLY ON APPROVAL OF YOUR PHYSICIAN.

Use and handling of video games to reduce the likelihood of a seizure

- Use in a well-lit area and keep as far away as possible from the television screen.
- Avoid large screen televisions. Use the smallest television screen available.
- Avoid prolonged use of the PS3™ system. Take a 15-minute break during each hour of play.
- Avoid playing when you are tired or need sleep.

Radio waves

Radio waves may affect electronic equipment or medical devices (for example, pacemakers), which may cause malfunctions and possible injuries.

- If you use a pacemaker or other medical device, consult your physician or the manufacturer of your medical device before using the wireless networking feature (Bluetooth® and wireless LAN).
- Do not use the wireless networking feature in the following locations:
 - Areas where wireless network use is prohibited, such as in hospitals. Abide by medical institution regulations when using the system on their premises.
 - Areas near fire alarms, automatic doors and other types of automated equipment.

3D images

Some people may experience discomfort (such as eye strain, eye fatigue, or nausea) while watching 3D video images or playing stereoscopic 3D games on 3D televisions. If you experience such discomfort you should immediately discontinue use of your television until the discomfort subsides.

SCE recommends that all viewers take regular breaks while watching 3D video, or playing stereoscopic 3D games. The length and frequency of necessary breaks may vary from person to person – please take breaks that are long enough to allow any feelings of discomfort to subside. If symptoms persist, consult your physician.

The vision of young children (especially those under six years old) is still under development. Consult with a physician (such as a pediatrician or eye doctor) before allowing a young child to watch 3D video images or play stereoscopic 3D games. When using any 3D enabled device with your PlayStation®3 system you should read the instruction manual for that device and visit www.us.playstation.com/support/3D for updated information.

PlayStation® and PlayStation®2 format software

This model of the PlayStation®3 system is designed to play PlayStation®3 format software and has limited backward compatibility. This system is not compatible with and will not play PlayStation®2 format software. Some PlayStation® format software may play on this system. For more information, visit www.us.playstation.com.

System software

The system software included within this product is subject to a limited license from Sony Computer Entertainment Inc. Refer to <http://www.scei.co.jp/ps3-eula> for further details.

About national export control

This product may fall within the scope of national export control legislation. You must comply fully with the requirements of such legislation and of all other applicable laws of any jurisdiction in relation to this product.

Notice about U.S. Export Administration Regulations

This product contains software that is subject to certain restrictions under the U.S. Export Administration Regulations, and may not be exported or re-exported to U.S. embargoed destinations. In addition this product may not be exported or re-exported to persons and entities prohibited by the U.S. Export Administration Regulations.

Precautions

Before using this product, carefully read all the precautions.

Safety

This product has been designed with the highest concern for safety. However, any electrical device, if used improperly, has the potential for causing fire, electrical shock or personal injury. To help ensure accident-free operation, follow these guidelines:

- Observe all warnings, precautions and instructions.
- Regularly inspect the AC power cord for damage.
- Stop use, unplug the AC power cord from the electrical outlet and disconnect any other cables immediately if the device functions in an abnormal manner, produces unusual sounds or smells or becomes too hot to touch.
- For more information on product safety and support, visit our website (→ back cover).

Use and handling

- Use in a well-lit area and keep as far away as possible from the television screen.
- Avoid prolonged use of the PS3™ system and wireless controller.
- Stop using the system immediately if you begin to feel tired or if you experience discomfort or pain in your hands or arms while operating the wireless controller. If the condition persists, consult a doctor.
- If you experience any of the following health problems, discontinue use of the system immediately. If symptoms persist, consult with your physician.
 - Dizziness, nausea, fatigue or symptoms similar to motion sickness
 - Discomfort or pain in a part of the body, such as eyes, ears, hands or arms
- Keep the system and accessories, including cable ties and fasteners, out of the reach of small children.
- Do not connect cables other than a USB cable while the system is turned on (power indicator is lit solid green).

- Do not place the system and connected accessories on the floor or in a place where they may cause someone to trip or stumble.
- Do not allow bodily contact with the system or air from the system vents for an extended period of time while in use. Extended contact under these conditions may cause low-temperature burns.
- When connecting the system to a plasma or projection* TV, do not leave a still image on the TV screen for an extended period of time, as this may leave a faint image permanently on the screen.
 - * Except LCD screen types
- Parents are encouraged to monitor children in online activities to ensure safe and responsible Internet usage.

Notes on safety when using the DUALSHOCK®3 Wireless Controller*

- Stop using the system immediately if you begin to feel tired or if you experience discomfort or pain in your hands or arms while operating the DUALSHOCK®3 Wireless Controller. If the condition persists, consult a doctor.
- The vibration function of the DUALSHOCK®3 Wireless Controller can aggravate injuries. Do not use the vibration function if you have any ailment or injury to the bones, joints or muscles of your hands or arms. If you have an ailment or an injury, do not play software titles that contain the vibration function using the DUALSHOCK®3 Wireless Controller unless you have set the vibration function to [Off].
- Avoid prolonged use of the DUALSHOCK®3 Wireless Controller. Take a break at about 30-minute intervals.
- Note that some software titles set the vibration function to [On] by default. To disable the vibration function, press the PS button of the controller, and then select [Controller Settings] → [Vibration Function] → [Off].
- When using the motion sensor function of the wireless controller, be cautious of the following points. If the controller hits a person or object, this may cause accidental injury or damage.
 - Before using, check that there is plenty of space around you.

- Any TV or component connected to the system must be functioning properly and free of defects. If a TV or component connected to the system is faulty or defective, it may cause damage to the TV or component, or to the system itself. As with all electrical products, connection to faulty or defective components, or the failure to connect to a properly wired outlet, may cause sparking and pose a fire hazard.
- Do not touch the system or connected cables or accessories during an electrical storm.
- Do not use the system or accessories near water.
- Do not allow liquid, small particles or other foreign objects to get into the system or accessories.
- Do not touch the connectors of the system or accessories.
- Do not expose the system or accessories to dust, smoke or steam. Also, do not place the system in an area subject to excessive dust or cigarette smoke. Dust build-up or cigarette smoke residue on the internal components (such as the lens) may cause the system to malfunction.
- Do not expose the system or accessories to high temperatures, high humidity or direct sunlight.
- Do not place the system or accessories on surfaces that are unstable, tilted or subject to vibration.
- Do not set the system other than in the vertical or horizontal position. When setting the system in the vertical position, use the vertical stand (sold separately) for this model of the system. Also, do not change the position of the system while it is turned on.
- Be careful when carrying the system. If you do not have a good grip, the system may drop causing potential damage or injury.
- Do not move or change the position of the system with a disc inserted. The vibration may result in scratching of the disc or the system.
- Do not turn off the system while data is being saved on or loaded from the hard disk.
- Do not stand on or put objects on the system, and do not stack the system with other devices.

- When using the controller, grip it firmly to make sure it cannot slip out of your hand.
- If using a controller that is connected to the PS3™ system with a USB cable, make sure there is enough space for the cable so that the cable will not hit a person or object. Also, take care to avoid pulling the cable out of the PS3™ system while using the controller.

* These notes also apply to other controllers.

Vents

Do not block any vents. To maintain good ventilation, follow the guidelines below:

- Place the system at least 10 cm (4 in) away from a wall surface.
- Do not place on a carpet or rug with long fibers.
- Do not place in a narrow or cramped space.
- Do not cover with cloth.
- Do not allow dust to build up on the vents.

AC power cord use

- Any TV or component connected to the system must be functioning properly and free of defects. If a TV or component is faulty or defective, it may cause damage to the TV or component, or to the system itself. As with all electrical products, connection to faulty or defective components, or the failure to connect to a properly wired outlet, may cause sparking and pose a fire hazard.
- Do not plug the AC power cord for the system into an electrical outlet until you have made all other connections. Make sure the TV or other component is unplugged from the electrical outlet prior to connecting it to the system.
- To help ensure safe operation, regularly inspect the AC power cord. If damaged, stop use immediately and contact SCEA Consumer Services (→ back cover).
- Do not use a power cord other than the supplied AC power cord. Do not modify the cord.

- Do not touch the plug of the AC power cord with wet hands.
- Protect the AC power cord from being walked on or pinched particularly at plugs, expansion receptacles and the point where the cord exits from the system.
- Do not place heavy items on the cord.
- Do not place the AC power cord near heating equipment and do not expose the cord to heat.
- Unplug the AC power cord from the electrical outlet before cleaning or moving the system, or when you do not intend to use the system for an extended period of time. When disconnecting, grasp the power cord by the plug and pull straight out of the electrical outlet. Never pull by the cord and do not pull out at an angle.
- Do not connect the AC power cord to a voltage transformer or inverter. Connecting the AC power cord to a voltage transformer for overseas travel or an inverter for use in an automobile may cause heat to build up in the system and may cause burns or a malfunction.

Never disassemble or modify the system or accessories

Use the PS3™ system and accessories according to the instructions in the product documentation. No authorization for the analysis or modification of the system or accessories, or the analysis and use of its circuit configurations, is provided. Unauthorized modification of the system or accessories will void your warranty. There are no user serviceable components inside the PS3™ system (the supplied hard disk may be removed but not disassembled or modified). Additionally, there is a risk of exposure to laser radiation as well as to electrical shock.

Network

- A broadband connection is required to access the Internet. Note that dial-up connectivity is not supported.
- User is responsible for Internet service fees. For details, refer to the information provided in your service contract or contact your Internet service provider.

Exterior surfaces (plastic cover of system and wireless controller)

Follow the instructions below to help prevent the product exterior from deteriorating or becoming discolored.

- Wipe with a soft, dry cloth.
- Do not place any rubber or vinyl materials on the product exterior for an extended period of time.
- Do not use solvents or other chemicals. Do not wipe with a chemically-treated cleaning cloth.

Vents

When dust accumulates in the system vents, remove the dust with a low-powered vacuum cleaner.

Discs

Note on compatibility

Some media may have region or territorial restrictions and may not work with your system. See media packaging for details.

Handling

- Do not touch the disc surface when handling a disc; hold it by the edges.
- Do not stick paper or tape onto discs and do not write on discs.
- Fingerprints, dust, dirt or scratches on the disc can distort the picture or reduce sound quality. Always handle carefully and check that discs are clean before use.

- Do not use a cord for a standard residential telephone line or cables of types other than those mentioned here. Using the wrong type of cord or cable can cause more electrical current than necessary to flow through the LAN connector, which may lead to heat build-up, fire or malfunction.

Wireless networking feature

- The 2.4 GHz range of radio waves used by the wireless networking feature of this product is a range shared by various devices. This product has been designed to minimize the effect of other devices using the same range. However, in some cases interference from other devices may reduce the connection speed, shorten the signal range or cause the connection to be terminated unexpectedly.
- When using the PS3™ system's scan function to select a wireless LAN access point, access points that are not intended for public use may be displayed. Only connect to an access point that you are authorized to use.

Moisture condensation

If the system or disc is brought directly from a cold location to a warm one, moisture may condense on the lens inside the system or on the disc. Should this occur, the system may not operate properly. In this case, remove the disc and turn off and unplug the system. Do not put the disc back in until the moisture evaporates (this may take several hours). If the system still does not operate properly, contact SCEA Consumer Services (→ back cover) for assistance.

Cleaning

For safety reasons, before cleaning the system or connected accessories, disconnect the AC power cord from the electrical outlet.

Storage

- Do not expose discs to high temperatures, high humidity or direct sunlight.
- When discs will not be used for an extended period of time, store them in their cases. Stacking uncased discs or storing them at an angle can cause them to warp.

Cleaning method

- Clean discs with a soft cloth, lightly wiping from the center outwards.
- Do not use solvents, record cleaners, anti-static spray or other chemicals as these can damage the discs.



XMB™ (XrossMediaBar) menu

The PS3™ system includes a user interface called XMB™ (XrossMediaBar).

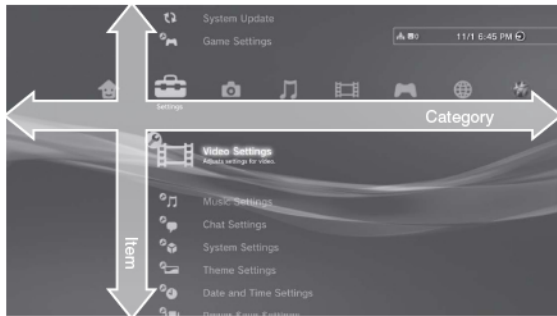

Options menu

Displayed by selecting an icon and pressing the **△** button



Control panel

Displayed by pressing the **△** button during content playback



PS button (Ⓟ) :

Displays the XMB™ menu
Turns the system on/off
Quits a game

△ button:

Displays the options menu/control panel

○ button:

Cancel an operation

× button:

Confirm the selected item

Directional buttons:

Used to select on-screen categories/items

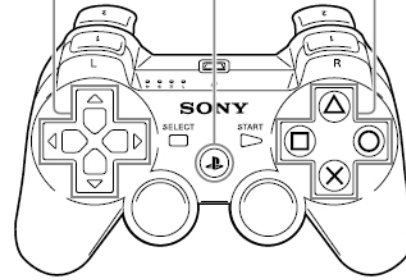

Part names

System front / rear

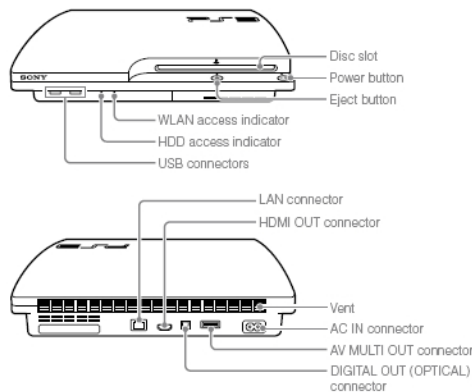

⚠ Caution

- Do not use the system in a closed cabinet or other locations where heat may build up. Doing so may cause the system to overheat and may lead to fire, injury or malfunction.
- If the system's internal temperature becomes elevated, the power indicator will flash alternately in red and green. In this case, turn off the system (→ page 21) and leave it unused for a while. After the system cools down, move it to a location with good ventilation, and then resume use.

DUALSHOCK®3 Wireless Controller

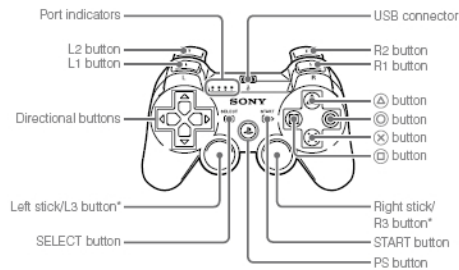

* The L3 and R3 buttons function when the sticks are pressed.

Notices

- Do not place the system in an area subject to excessive dust or cigarette smoke. Dust build-up or cigarette smoke residue on the internal components (such as the lens) may cause the system to malfunction.
- Do not move or change the position of the system while the power indicator is lit solid green or flashing green. The vibration that occurs as a result of moving the system may cause data loss or corruption, or damage to the system.
- Some PlayStation® and PlayStation®2 peripherals such as the analog controller (DUALSHOCK®) and analog controller (DUALSHOCK®2) are not compatible with the PS3™ system. For details, visit www.us.playstation.com.

Hint

When placing the system in a vertical position, use of the vertical stand (sold separately) is required for stability.

Part names

System front / rear

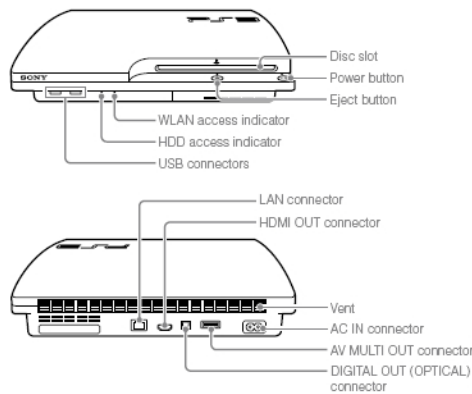

Caution

- Do not use the system in a closed cabinet or other locations where heat may build up. Doing so may cause the system to overheat and may lead to fire, injury or malfunction.
- If the system's internal temperature becomes elevated, the power indicator will flash alternately in red and green. In this case, turn off the system (→ page 21) and leave it unused for a while. After the system cools down, move it to a location with good ventilation, and then resume use.

DUALSHOCK®3 Wireless Controller

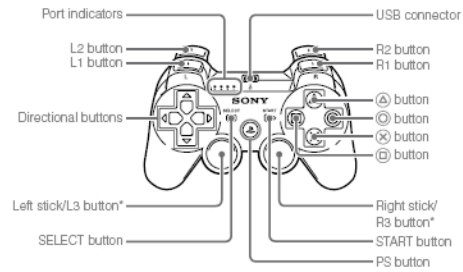

* The L3 and R3 buttons function when the sticks are pressed.

Notices

- Do not place the system in an area subject to excessive dust or cigarette smoke. Dust build-up or cigarette smoke residue on the internal components (such as the lens) may cause the system to malfunction.
- Do not move or change the position of the system while the power indicator is lit solid green or flashing green. The vibration that occurs as a result of moving the system may cause data loss or corruption, or damage to the system.
- Some PlayStation® and PlayStation®2 peripherals such as the analog controller (DUALSHOCK®) and analog controller (DUALSHOCK®2) are not compatible with the PS3™ system. For details, visit www.us.playstation.com.

Hint

When placing the system in a vertical position, use of the vertical stand (sold separately) is required for stability.

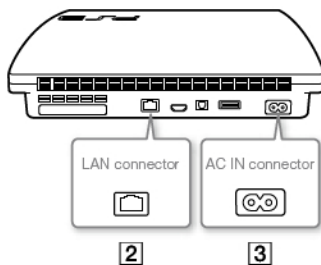

2 Connect an Ethernet cable (sold separately)

Use an Ethernet cable to connect the system to the Internet.

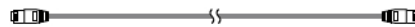

Hint

You can use a wireless network connection to connect to the Internet without using an Ethernet cable. For details, see 'Adjusting network settings' (→ page 28).

Caution

Do not connect a standard telephone line or other types of cords or cables that are not compatible with the system directly to the LAN connector on the system, as this may cause heat build-up, fire or malfunction.

3 Connect the AC power cord

After plugging the AC power cord into the electrical outlet, the power indicator on the PS3™ system will light up in solid red (→ page 21).



Caution

Do not plug the AC power cord for the system into an electrical outlet until you have made all other connections. Make sure the TV or other component is unplugged from the electrical outlet prior to connecting it to the system.

Performing initial setup of the system software

After turning on the system, perform initial setup.

1 Turn on the TV, and then switch the video input of the TV to match the input connector used by the PS3™ system.

2 Press the power button.

The power indicator turns green and the picture is displayed on the TV screen.



3 Connect the wireless controller to the system using a USB cable.

4 Press the PS button on the controller.

The system will recognize the controller. After it has recognized the controller, the initial setup screen will be displayed.

5 Perform initial setup.



Follow the on-screen instructions to enter settings for system language, time zone, date and time, and user name.

The screen for setting up the Internet connection will be displayed. When connecting using an Ethernet cable, basic settings will be selected automatically if you follow the on-screen instructions. When connecting over a wireless LAN, follow the instructions in 'Adjusting network settings (wireless)' (→ page 29) to set up the connection.

After the settings have been completed, the XMB™ menu (→ page 11) will be displayed on the TV screen.

Hints

- When using an HDMI cable to connect the system to the TV, a screen for changing the video output resolution will be displayed during initial setup. If you select [Yes] on the screen and then press the (X) button, the optimal output resolution will be selected automatically.
- For details on entering text, see 'Using the on-screen keyboard' (→ page 34).
- Settings entered during initial setup can be changed under (Settings) or (Users). For details, refer to the online user's guide (<http://manuals.playstation.net/document/>).

Video output on the PS3™ system

The PS3™ system can output two types of resolution: HD and SD. Refer to the instruction manual for the TV in use to check which video mode is supported.

Video mode **	HD (High Definition)			SD (Standard Definition)	
	1080p	1080i	720p	480p	480i **
Aspect ratio	16:9	16:9	16:9	16:9 4:3	16:9 4:3

*1 This number indicates the number of scan lines. Note that 'i' stands for 'interlace' and 'p' stands for 'progressive'. Using progressive results in high-quality video with minimal flickering.

** The video output setting on the system will display as [Standard (NTSC)].

Screens showing the difference in resolution



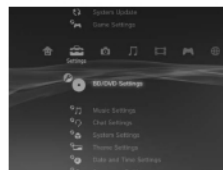

HD screen



SD screen

Video output cable types

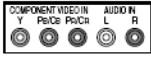
The resolution displayed on the TV varies depending on the input connectors on the TV and the type of cable in use. Select a cable to match the TV in use.

Cable type	Input connector on the TV	Supported video modes*1
HDMI Cable*2 (sold separately)	HDMI IN connector 	1080p / 1080i / 720p / 480p
Component AV Cable (sold separately)	Component VIDEO IN connector 	1080p / 1080i / 720p / 480p / 480i*3
S VIDEO Cable (sold separately)	S VIDEO IN connector 	480i*3
AV Cable (supplied)	VIDEO IN connector (composite) 	480i*3

*1 Depending on the type of TV or content to be played, some video modes may not be supported.

If a device that is not compatible with the HDCP (High-bandwidth Digital Content Protection) standard is connected to the system using an HDMI cable, video and/or audio cannot be output from the system.

Copyright-protected Blu-ray video discs can only be output at 1080p using an HDMI cable connected to a device that is compatible with the HDCP (Highband-width Digital Content Protection) standard.

*2 Connect the system to the TV using an HDMI cable (sold separately). An HDMI cable can output both video and audio and enables you to enjoy digital-quality video and audio.

*3 The video output setting on the system will display as [Standard (NTSC)].

Adjusting video output settings

Depending on the type of cables and the connectors used, you may need to adjust the PS3™ system's video output settings to display video at HD resolutions (→ page 16) on a TV.

If video is not displayed

- Switch the video input of the TV to match the input connector used to connect to the system.
- Turn off the system, and then turn it on again by pressing the power button for at least five seconds (until the system beeps twice). The video output setting will be reset and video will be output at standard definition (SD) resolution.

1 Select  (Settings) →  (Display Settings) → [Video Output Settings], and then press the  button.

2 Select the input connector (→ page 17) in use on the TV, and then press the  button.



If you select [HDMI], you will have the option to choose [Automatic] or [Custom] on the next screen. In most cases, select [Automatic], and video output settings will be completed automatically.

If you select [AV MULTI / SCART], you must choose the type of output signal on the next screen. In most cases, select [Y Pb/Cb Pr/Cr].

3 Confirm the screen, and then press the  button.

If you changed the connector in step 2, a screen for confirming the change will be displayed.

4 Confirm the settings, select [Yes], and then press the  button.

If you changed the connector in step 2, a screen for confirming the settings will be displayed.



5 Select the resolutions supported by the TV, and then press the  button.

The resolution displayed on the TV varies depending on the input connector and the type of cable used (→ page 17). The highest resolution you selected will be used for video output.

Depending on the connector selected in step 2, this screen may not be displayed.



- 6 Confirm the settings, select [Yes], and then press the \otimes button.**
Depending on the connector selected in step 2 and the resolutions selected in step 5, this screen may not be displayed.



- 7 Select the type of TV, and then press the \blacktriangleright button.**
If you selected [Standard (NTSC)] or [480p] in step 5, a screen for selecting the TV screen size will be displayed. Adjust the setting to match the TV in use.
If you selected [720p] or a higher resolution in step 5, the TV type will automatically be set to 16:9 and the screen for selecting the TV screen size will not be displayed.

- 8 Confirm the settings, and then press the \otimes button.**
The video output settings will be saved on the system.

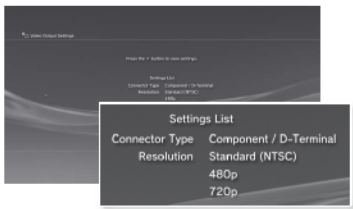

- 9 Adjust audio output settings.**
Continue on to adjust audio output settings. Adjust settings to match the TV or audio device in use.

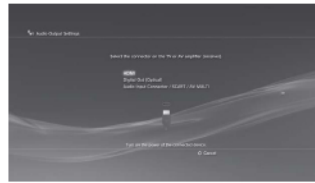

If you select [HDMI], you will have the option to choose [Automatic] or [Manual] on the next screen. In most cases, select [Automatic].

If using a cable other than an HDMI cable to output audio from the TV, select [Audio Input Connector / SCART / AV MULTI]. If using an optical digital cable to output audio, select [Digital Out (Optical)] and choose the output format on the next screen.

- 10 Confirm the settings, and then press the \otimes button.**
The audio output settings will be saved on the system.

Hints

- You can adjust audio output settings under Settings \Rightarrow Sound Settings \Rightarrow [Audio Output Settings].
- If the TV in use supports 3D Stereoscopic display, a screen for setting the TV's screen resolution will be displayed after step 2. Follow the on-screen instructions to adjust the settings. Using an HDMI cable, connect the PS3™ system to a TV that supports 3D Stereoscopic display.

Connecting digital audio devices

You can connect audio devices that support digital audio playback, such as an AV receiver for home entertainment use.

Audio output on the PS3™ system

The supported channels may vary depending on the output connector to be used.

PS3™ system output connectors	Channels that can be used for output		
	2 Ch.	5.1 Ch.	7.1 Ch.
AV MULTI OUT connector	○	–	–
DIGITAL OUT (OPTICAL) connector	○	○	–
HDMI OUT connector	○	○	○

Hints

- When connecting a digital audio device to the system, go to Settings \Rightarrow Sound Settings \Rightarrow [Audio Output Settings], and then adjust the settings as necessary for the audio device.
- For simultaneous audio output from multiple connectors, go to Settings \Rightarrow Sound Settings \Rightarrow [Audio Multi-Output], and set the option to [On].
- The system can output both audio and video through an HDMI cable. If both the TV and the audio device have HDMI connectors, you can output the TV picture to the TV through a connected audio device.
- If a device is connected to the PS3™ system via an HDMI cable, do not turn off the device while the system is turned on (power indicator is lit solid green), as doing so may cause sound distortion or produce abnormal sounds.

Examples when connecting an audio device

An HDMI cable or optical digital cable can be used to connect an audio device to the PS3™ system.

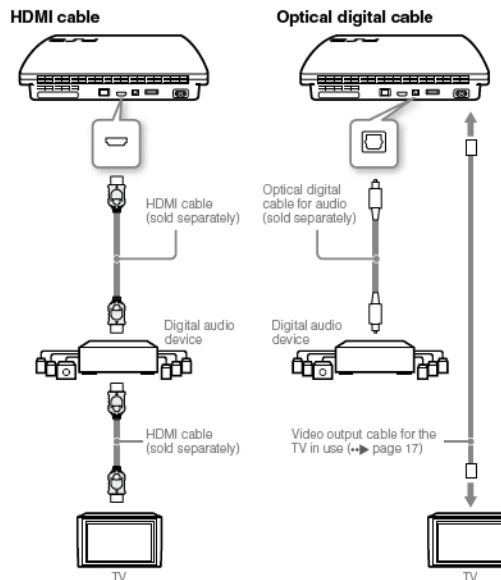

Turning the PS3™ system on and off

Turning on the system

1 Press the power button.

The power indicator lights up in solid green to indicate that the system is turned on.



2 Press the PS button on the controller.

After the controller number is assigned, you can use the controller to operate the system.

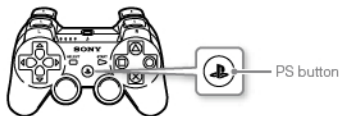

Power indicator status

You can check the power indicator on the PS3™ system to see the current status of the system.

○	Solid green	System on
◐	Flashing green	System turning off
●	Solid red	System off (in standby mode)

Turning off the system

1 Press the power button.

The power indicator lights up in solid red.



Notice

When the power indicator is lit solid green or flashing green, be sure to abide by the notices below. If you do not, data loss or corruption, or damage to the system may occur.

- Do not unplug the AC power cord from the electrical outlet.
- Do not move or change the position of the system.

Hints

- Before using a wireless controller, you must first pair it with the system (→ page 22).
- You can also turn the PS3™ system on and off using the PS button on the wireless controller. If you use the PS button to turn on the system, the controller number will be assigned at the same time. To turn off the system, press the PS button for more than one second, and then follow the on-screen instructions.
- You can also turn off the PS3™ system from the XMB™ menu. Select (Users) → (Turn Off System).
- If you will not be using the system for a long period of time, check that the power indicator is lit solid red, and then unplug the AC power cord from the electrical outlet.

Using the wireless controller

Preparing for use

To use a wireless controller, you must first register or "pair" the controller with the PS3™ system and assign a number to the controller.

Step 1: Pair the system and the controller.

- When using for the first time
- When using with a different PS3™ system

Step 2: Assign a controller number.

Every time the system is turned on

Step 1: Pair the system and the controller

When using the controller for the first time or when using with a different PS3™ system, you must first pair the devices. If you turn on the system and connect the controller using a USB cable, the pairing will be completed automatically.

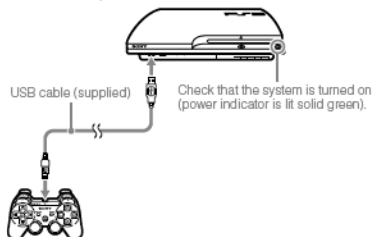

Step 2: Assign a controller number

Each time you turn on the system, a number must be assigned to the controller.

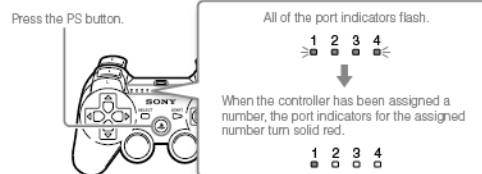

You can connect up to 7 controllers at one time. The controller number is shown by the number above the port indicators. For numbers 5-7, add the numbers of the lit indicators.

Example: Controller number 5 has been assigned.

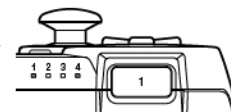

Hints

- Pairing and assigning controller numbers can only be done when the system is turned on (power indicator is lit solid green).
- When a paired controller is used with another PS3™ system, the pairing with the original system is cleared. Pair the controller with the system again if the controller has been used with another system.
- If the controller or the system is turned off, the port indicators on the controller will turn off and the assigned number will be cleared.

Using the controller wirelessly

If you disconnect the USB cable, you can use the controller wirelessly. To use it wirelessly, the controller's battery must be charged.

Hints

- The USB cable can be connected or disconnected while the controller and the system are turned on.
- If the controller does not function, press the PS button, and then reassign the controller number.

Charging the controller

With the system turned on (power indicator is lit solid green), connect the controller to the system using a USB cable. The port indicators of the controller flash slowly and charging begins. When charging has completed, the port indicators stop flashing.

Hints

- The controller can be used while charging.
- Charge in an environment where the temperature range is between 10°C - 30°C (50°F - 86°F). Charging may not be as effective when performed in other environments.
- The controller cannot be charged when the system is off (in standby mode).
- The battery has a limited life span. Battery charge duration will gradually decrease with repeated usage and age.
- Battery life also varies depending on the storage method, usage state, environment and other factors.

Battery charge level

If you press and hold down the PS button for more than one second, you can check the battery charge level on the screen.

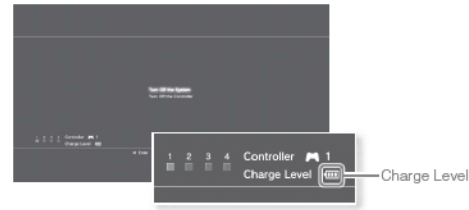

	The battery has plenty of charge.
	The battery has started losing its charge.
	The battery charge level is low.
	The battery has no charge. The port indicators on the controller flash rapidly. Charge the controller.

Hint

Depending on the environment or the conditions of use, the remaining charge level may not display correctly and the battery duration may vary.

Playing content

Blu-ray Disc (BD)/DVD/CD

1 Insert the disc.

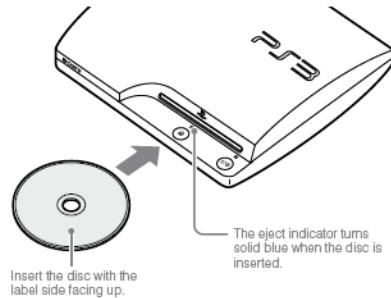

2 An icon is displayed in the XMB™ menu, and playback of the disc begins.



If the disc does not automatically start, select the icon for the disc from the XMB™ menu, and then press the button.

Notices

- Do not insert multiple discs or foreign objects into the disc slot, because this may cause the system to malfunction.
- Discs that are not compatible with the system cannot be played.
- To play commercially available BD video software, in some cases the encryption key* may need to be renewed. The encryption key can be renewed when the system software is updated (→ page 33).
* AAC (Advanced Access Control System) key

Ejecting a disc

Stop playback, and then press the eject button.

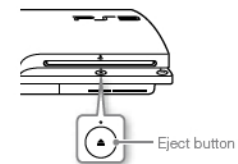

Playing content on USB devices

You can connect external devices, such as devices that are compatible with USB Mass Storage Class, using a USB cable. Devices can be connected while the system is turned on. Refer also to the instructions supplied with the device.

1 Connect the USB device.

An icon is displayed on the screen.

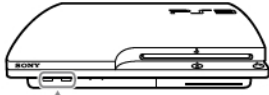

External device such as a digital camera

2 Select the icon, and then press the **X** button.

A list of playable content is displayed.



Notices

- Do not remove USB devices or turn off the system while data is being saved, loaded or deleted. Doing so may cause data loss or corruption.
- When using a USB flash drive with a write-protect switch, do not operate the switch when the device is connected to the system. Doing so may cause data loss or corruption.

File formats that can be played or viewed

File formats that can be played or viewed on this system include ATRAC™, MP3, AAC, JPEG and MPEG-4. For the latest information, refer to the online user's guide (<http://manuals.playstation.net/document/>).

Hints

- Only files that are playable or viewable on the PS3™ system are displayed in the column for the compatible category (Example: Image data is displayed under **P** (Photo)).
- Depending on the storage media, only a subset of the folders on the media may be displayed. If you select [Display All] from the options menu (→ page 11), all folders saved on the media will be displayed.

Notice

For information on backing up files saved on the hard disk, see 'Backing up data' (→ page 36).

Playing games

Game compatibility

PlayStation ³ format software	Can be played on this system *
PlayStation ⁴ format software	
PlayStation ² format software	Cannot be played on this system

* Operation of all PlayStation⁴ format software titles is not guaranteed. Visit www.us.playstation.com for the latest information on software that can be played on this system.

Playing games

This model of the PlayStation³ system is designed to play PlayStation³ format software and has limited backward compatibility. This system is not compatible with and will not play PlayStation² format software. Some PlayStation⁴ format software may play on this system. For more information, visit www.us.playstation.com.

Starting a game

When you insert the disc, the game starts automatically.

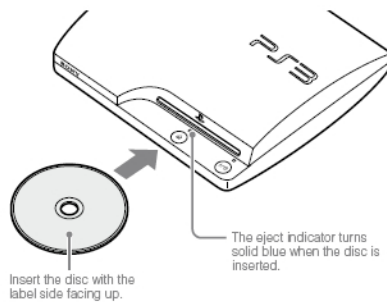

Insert the disc with the label side facing up.

The eject indicator turns solid blue when the disc is inserted.

Notice

Do not insert multiple discs or foreign objects into the disc slot, because this may cause the system to malfunction.



Quitting a game

During gameplay, press the PS button on the wireless controller. Then select **Game** (Game) → **Quit Game** (Quit Game) to quit the game.

Hint

Depending on the type of software, such as PlayStation⁴ format software, **Quit Game** (Quit Game) may not be displayed when the PS button is pressed. In this case, select [Quit Game] from the screen that is displayed.



Controller settings

You can change controller settings by selecting  (Settings) \Rightarrow  (Accessory Settings).



Reassign Controllers	If a controller port or number is specified by the software, you can use this setting to assign the appropriate controller port or number.*
Controller Vibration Function	You can set the vibration function to on or off. It is set to [On] by default.

* You cannot assign controller port 2-D using this system.

Hint

You can change settings for the controller during gameplay by pressing the PS button. Select  (Settings) \Rightarrow  (Accessory Settings) in the XMB™ screen, or select [Controller Settings] from the screen that is displayed.

Saved data for PlayStation®3 format software

Saved data for PlayStation®3 format software is saved on the system's hard disk. The data is displayed under  (Game) \Rightarrow  (Saved Data Utility).



Saved data for PlayStation® format software

To save data from PlayStation® format software, you must create internal memory cards on the hard disk and assign the cards to slots.



Notice

This system does not support playback of PlayStation®2 format software. Even if you create an internal memory card for PlayStation®2 format software, you will not be able to use it to play games.

Creating internal memory cards

- 1 Select  (Game) \Rightarrow , and then press the \otimes button.
- 2 Select \square^+ (Create New Internal Memory Card), and then press the \otimes button.
- 3 Select [Internal Memory Card (PS)], and then press the \otimes button. Follow the on-screen instructions to complete the operation.

Assigning slots

- 1 Select  (Game) \Rightarrow , and then press the \otimes button.
- 2 Select the internal memory card that you want to use, and then press the \triangle button. Select [Assign Slots], and then assign [Slot 1] or [Slot 2].

Hints

- Depending on the software, slots may be preassigned. For details, refer to the instructions supplied with the software.
- You can assign slots during gameplay. Press the PS button on the wireless controller, and then select [Assign Slots] from the screen that is displayed.

Adjusting network settings

Example of a network configuration (wired)

A wired network configuration requires items **1**, **2** and **3**.

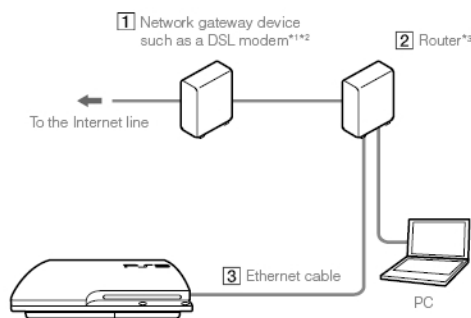

Example of a network configuration (wireless)

A wireless network configuration requires items **1** and **2**.

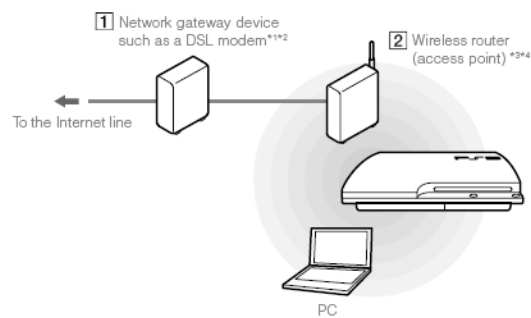

**1 The connection method may vary depending on the environment in use. For example, you may be able to connect Ethernet cables directly into the wall outlet in housing complex units that have preinstalled LAN ports. If you are using such a network environment, you do not need a network gateway device.

**2 Dial-up connectivity is not supported.

**3 A router is a device that enables multiple devices to be connected to one Internet line. A router may be necessary if a PS3™ system and other devices such as a PC will be connected to the Internet at the same time using one Internet connection. A router is not necessary if the DSL or cable modem or other network device has built-in router functionality.

**4 A wireless router is a device that adds access point functionality to a router. A wireless network configuration requires settings information for the access point (SSID, WEP key, WPA key) (→ page 30).

Adjusting network settings (wired)

- 1 Connect an Ethernet cable (sold separately) to the system.
- 2 Select **Settings** ⇒ **Network Settings** ⇒ **[Internet Connection Settings]**, and then press the **⊗** button.
A confirmation message about the Ethernet cable is displayed.

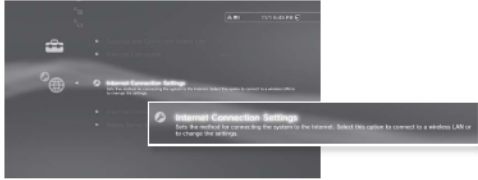

- 3 Select **[OK]**, and then press the **⊗** button.
- 4 Select **[Easy]**, and then press the **▶** button.
Basic settings are adjusted automatically, and a list of the settings is displayed. If the list is not displayed, you must adjust custom settings. Refer to the instructions supplied by your Internet service provider to adjust the custom settings (→ page 31).
- 5 **Perform the Internet connection test.**
If the connection is successful, you will be able to connect to the Internet.

Adjusting network settings (wireless)

- 1 Check that an Ethernet cable is not connected to the system.
- 2 Select **Settings** ⇒ **Network Settings** ⇒ **[Internet Connection Settings]**, and then press the **⊗** button.
A confirmation message about the Ethernet cable is displayed.

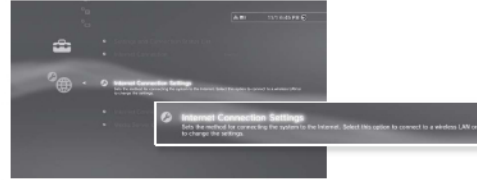

- 3 Select **[OK]**, and then press the **⊗** button.
- 4 Select **[Easy]**, and then press the **▶** button.
Basic settings are adjusted automatically.
- 5 Select **[Wireless]**, and then press the **▶** button.

6 Adjust wireless LAN settings.

Select the access point that you want to use. You can usually select **[Scan]** and choose an access point within range of your system.

Scan	System scans for a nearby access point. Select the access point that you want to use.
Enter Manually	Specify the access point by entering its SSID manually.
Automatic*	Use the automatic setting feature of the access point. You can follow the on-screen instructions to complete the required settings automatically.  AOSS™ Buffalo, Inc.

* For information on access points that support automatic setup (AOSS™), contact the access point manufacturers.

7 Adjust the security settings for the wireless network.

Enter the encryption key for the access point. If you selected **[Automatic]** in step 6, this screen will not be displayed.

None	Encryption key is not set.
WEP	Enter the encryption key. The encryption key field will display an asterisk (*) for each character you enter.
WPA-PSK/ WPA2-PSK	

8 Check the settings.

A list of the settings is displayed. If the list is not displayed, you must adjust custom settings. Refer to the instructions supplied by your Internet service provider to adjust the custom settings (→ page 31).

9 Perform the Internet connection test.

If the connection is successful, you will be able to connect to the Internet.

Hints

- SSID and WEP/WPA keys are types of security information that are required when connecting to an access point. If you do not have this information, contact the person who set up or maintains the access point.
- Depending on the access point you use, you may need the MAC address for the PS3™ system when connecting to the Internet. You can find the MAC address for the PS3™ system by going to **Settings** ⇒ **System Settings** ⇒ **[System Information]**.
- When connecting to the Internet wirelessly, signal interference may occur depending on the usage condition of the wireless network devices. If the Internet data transfer speed is decreased or the wireless controller does not function properly, try using a wired Internet connection.

Adjusting custom settings

In certain network environments, some settings may not be adjusted automatically by selecting [Easy]. Refer to the information below and also follow the on-screen instructions to adjust custom settings.

Ethernet operation mode

Specify the Ethernet data transfer rate and operation method. You can usually select [Auto-Detect].

IP Address Setting

Specify the method for obtaining an IP address when connecting to the Internet. The method varies depending on the Internet service provider you use.

Automatic	Use the IP address allocated by the DHCP server.
Manual	Enter the IP address manually.
PPPoE	Connect to the Internet using PPPoE. Enter the user name and password supplied by your Internet service provider.

DHCP host name

Specify the DHCP server host name. You can usually select [Do Not Set].

DNS Setting

Specify the DNS server. The method varies depending on the Internet service provider you use.

Automatic	System acquires the DNS server address automatically.
Manual	Enter the DNS server address manually. Enter the IP addresses of the primary and secondary DNS servers that are supplied by your Internet service provider.

MTU

Specify the MTU value used when transmitting data. You can usually select [Automatic].

Proxy Server

Specify the proxy server to be used. You can usually select [Do Not Use].

UPnP

Enable or disable UPnP (Universal Plug and Play). You can usually select [Enable].

Hint

If [UPnP] is set to [Disable], online communication may be restricted when using the voice / video chat feature or communication features in games.

Connecting to the Internet

If network settings are already completed, the PS3™ system will automatically connect to the Internet when the system is turned on. The connection will remain active as long as the system is on.

Using the Internet browser

- 1 Select **(Network)** ⇒ **(Internet Browser)**, and then press the **(X)** button.

The Internet browser opens. A busy icon is displayed while the page is loading.

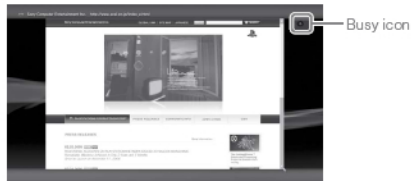

Basic operations of the Internet browser

Directional buttons	Move the pointer to a link.
Right stick	Scroll in the desired direction.
L1 button	Go back to the previous page.
START button	Enter an address.
(A) button	Switch between displaying and not displaying the menu.

Viewing the user's guide

You can use the Internet browser to view the online user's guide for the PS3™ system. Select **(Network)** ⇒ **(?)** (Online Instruction Manuals), and then press the **(X)** button.

Online user's guide <http://manuals.playstation.net/document/>
This guide contains detailed information about using the PS3™ system software.

Creating a PlayStation®Network account

By creating a PlayStation®Network account, you can enjoy communicating with your Friends or download games or videos from **(PlayStation®Store)**. Select **(PlayStation®Network)** ⇒ **(Sign Up for PlayStation®Network)**, and then press the **(X)** button. The screen for creating an account will be displayed.



Hints

- An Internet connection is required to create an account.
- PlayStation®Network service content may vary depending on the region.
- You can also create a PlayStation®Network account at www.us.playstation.com.

PS3™ system updates

By updating the PS3™ system software, you can add features and/or security patches. Frequently update your system to use the latest version of the system software.

System software updates www.us.playstation.com/ps3
This site provides the latest information about system software updates.



Notices

- During an update, do not turn off the system or remove media. If an update is cancelled before completion, the system software may become damaged, and the system may require servicing or exchange.
- During an update, the power button on the system and PS button of the controller are inactive.
- Depending on the content, you may not be able to play without first updating the system software.
- After you have updated the system software, you cannot go back to an earlier version.

Checking the system software version

You can check system version information by selecting **Settings** → **System Settings** → **System Information**. The current version is displayed in the **[System Software]** field.

Update methods

You can perform an update in any of the ways described below.

Network update

You can update by downloading the update data from the Internet. The latest update is automatically downloaded.

Select **Settings** → **System Update** → **[Update via Internet]**.

Update using storage media

You can update using the update data saved on a USB flash drive or other media.

Select **Settings** → **System Update** → **[Update via Storage Media]**.

Update using disc media

Update data may also be contained in some game discs and other types of disc media. When you play a disc that contains update data, a screen will be displayed to guide you through the update process.

Hint

If you cannot perform an update in any of the ways described above, contact SCEA Consumer Services (→ back cover).

Using the on-screen keyboard

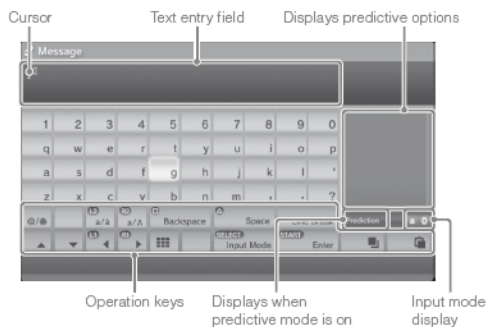

Entering text

The following steps explain how to enter text, using the word "fun" as an example.

- 1 Select [f] on the keyboard, and then press the **⊗** button.**
Repeat this step for the characters [u] and [n].
- 2 Select [Enter], and then press the **⊗** button.**
The characters you entered are confirmed.
- 3 Select [Enter], and then press the **⊗** button again.**
The text is entered and the keyboard closes.

Hints

- For details about using the on-screen keyboard, refer to the online user's guide (<http://manuals.playstation.net/document/>).
- You can also enter text using a USB keyboard or Bluetooth-compatible keyboard (both sold separately). With the on-screen keyboard displayed, press any key on the connected keyboard to start entering text.

List of keys



Keys that are displayed vary depending on the input mode and other conditions.

Keys	Explanation
Line Break	Inserts a line break
← →	Moves the cursor
Backspace	Deletes the character to the left of the cursor
Space	Inserts a space
Input Mode	Switches the input mode
Enter	Confirms characters that have been typed and then closes the keyboard
Mini-keyboard icon	Switches to the mini-size keyboard
*%# / @/Ⓜ	Inserts a symbol or emoticon
α/A / Ω/Ω	Switches the type of characters to be entered
Ⓜ / Ⓜ	Copies or pastes text

Parental control

The PS3™ system includes a parental control feature. You can use this feature to set a password and limit the playback of content restricted by a parental control level (games, videos and other content) for children. For more information on parental control settings, visit www.us.playstation.com.

Changing the security settings

You can set a parental control level for games or Blu-ray Discs or other content under  (Settings) ⇒  (Security Settings).

A password is required to change parental control settings. You can set a password under  (Security Settings) ⇒ [Change Password]. The password is set to "0000" in the default settings.



Parental control levels for games

You can set the parental control level for games under  (Security Settings) ⇒ [Parental Control]. Select from [Off] or one of 11 levels.

Off	Play any content regardless of parental control level.
11-1	Set the parental control level based on the number. Note that the lower the number, the tighter the restriction.







The combination of the parental control levels of both the PS3™ system and the content determine whether the content can be played.

Example: If the parental control level of the system is set to [7], content with a level from [1] to [7] can be played on the system.

You can see the parental control level of a game or video that you downloaded from  (PlayStation®Store). Select the game or video, and then press the  button. From the options menu, select [Information] to display a screen with the parental control level.

Game rating marks

Most game packaging displays a symbol to indicate the age group that is appropriate to play the game. The symbols correspond to the parental control levels set on the games as shown below.

Age group						
Game parental control level	2	3	4	5	9	10

Based on information at time of publication. For more information, visit www.us.playstation.com/support. For the latest information about the ESRB rating system, visit <http://www.esrb.org>.

Other security settings

You can set parental control limitations on content other than games under  (Security Settings), as described below.

BD Parental Control	When playing a BD with parental control settings, restrict playback based on the age you have set. The lower the setting, the tighter the restriction.
DVD parental control	When playing a DVD with parental control settings, restrict playback based on the level you have set. Select from [Off] or one of eight levels. The lower the number, the tighter the restriction.
Internet Browser Start Control	Restrict the ability to start the Internet Browser with a password.

Hint

For information about parental control settings for PlayStation®Network content and services, visit www.us.playstation.com/support.







Replacing the hard disk

You can replace the hard disk that is installed in the PS3™ system.

⚠ Caution

- Remove the hard disk in a location out of the reach of small children to help prevent accidental swallowing of small parts such as screws.
- The inside of the system is hot directly after use. Allow time for the system to cool down before starting to remove the hard disk.
- Be careful not to injure yourself when removing or handling the screw cover or the hard disk.
- Be sure to reattach the screw cover and the HDD bay cover before turning the PS3™ system on. If these covers are not attached, heat may build up inside the system.
- To attach or remove screws, use an appropriate crosshead screwdriver. If the size does not match, the groove on the screw's head may be damaged.

Notices

- All hard disks, including a PS3™ system's hard disk, must be reformatted before use in a PS3™ system.
- It is recommended that you regularly back up data on the hard disk. If for any reason software or data loss or corruption occurs, it may not be possible to restore or repair the software or data. Sony Computer Entertainment Inc. and its subsidiaries and affiliates will not be liable for damage or injury related to software or data loss or corruption.
- You can back up data stored on the hard disk to a USB mass storage device and restore data that has been backed up. For details, see "Backing up data" (→ page 36).
- Improper removal or installation of a hard disk may cause damage to your PS3™ system or loss of data, and may void your PS3™ system's hardware warranty. SCEA shall not be liable for any resulting damages, including any damages to your hard disk. User assumes all risks and liabilities associated with using a replacement hard disk, including any incompatibility or interoperability problems with the PS3™ system. Services will not be provided on any non-PS3™ system hard disks.
- To help protect your personal information, be sure to clear passwords for all PlayStation®Network accounts before submitting the PS3™ system for service. To clear a password, select  (PlayStation®Network) ⇒  (Sign In), and then from the screen that is displayed, clear the [Save Password] checkbox. Note that if [Sign In Automatically (Auto Sign-In)] is set, the icon for  (Sign In) will no longer be displayed. In that case, you must first clear the auto sign-in option. To clear the auto sign-in option, select  (PlayStation®Network) ⇒  (Account Management), press the  button, and then select [Auto Sign-In Off] from the options menu. After the auto sign-in option is turned off, proceed with the password clearing process.

Backing up data

You can back up data that is saved on the hard disk using either of the following methods.

Notice

It is recommended that you regularly back up data on the hard disk. If for any reason software or data loss or corruption occurs or the hard disk must be initialized during authorized service, it may not be possible to restore or repair the software or data. Sony Computer Entertainment Inc. and its subsidiaries and affiliates will not be held liable for damage or injury related to software or data loss or corruption.

Backing up data in a single operation

You can back up data that is saved on the hard disk to a USB mass storage device in a single operation. Select **(Settings)** → **(System Settings)** → **[Backup Utility]**, and then follow the on-screen instructions to perform this operation. You may not be able to back up some content, including some types of copyright-protected data.

Hint

You may not be able to use the backup utility to restore some data. For important data that cannot be backed up, it is recommended that you selectively copy or move the data to a USB storage device before you use the backup utility feature. For details on the backup utility feature, refer to the online user's guide (<http://manuals.playstation.net/document/>).

Backing up selected data

The following file types saved on the system's hard disk can be copied or moved to a USB device. Select the file, press the **(△)** button, and then select **[Copy]** or **[Move]** from the options menu. For some types of video files, you may need to select **[Back Up]** instead.

File type	Back up destination
Saved data from games; video, music or photo files	USB mass storage device (USB flash drive, etc.)

Hints

- Some data cannot be copied, moved or backed up.
- By using a card reader/writer (USB connector type, sold separately), you can back up files saved on the hard disk to storage media such as a Memory Stick™ or an SD Memory Card.

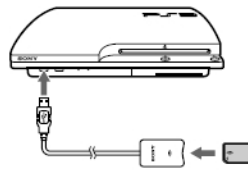

Removing the hard disk

Caution

- For safety reasons, be sure to turn off and unplug the system before attempting to remove the hard disk.
- The system may not be stable when placed upside down. Be careful not to injure yourself when removing the screw.

1 Press the power button to turn off the system.

The power indicator turns solid red and the system enters standby mode.

2 Unplug the AC power cord, and then disconnect the other cables from the system.

For safety reasons, remove the plug for the power cord from the electrical outlet, and then detach the other cables.

3 Place the system upside down on a soft, dry cloth, and then open the screw cover.

Use the notch located above the screw cover to slightly pull up the cover. Then rotate the cover as shown in the diagram. If the cover is hard to pull up, insert a tool such as a flathead screwdriver in the notch and gently pull the cover up.

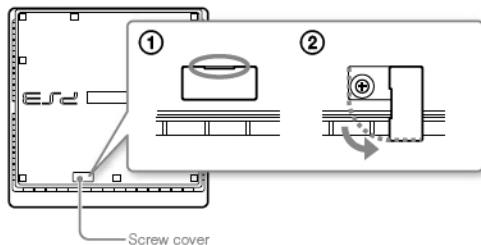

4 Remove the screw that fastens the hard disk in place, and then remove the HDD bay cover.

- ① Remove the blue screw with an appropriate crosshead screwdriver.
- ② Slide the HDD bay cover to the left, and then remove the cover.

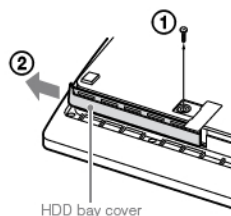

5 Remove the hard disk.

Pull the handle upwards, and then pull out the hard disk from the system.

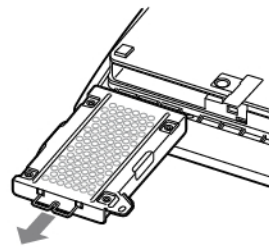

Notices

The hard disk is a sensitive piece of equipment and should be handled with care at all times. To help prevent software or data loss or corruption, or damage to the hard disk, carefully follow the precautions listed below:

- Do not throw or drop the system or hard disk, or otherwise expose either device to strong vibrations or strong physical impact.
- Do not allow liquid or small particles to get into the system or hard disk.
- Do not touch the connectors or insert foreign objects into the connectors.
- Do not place the system or hard disk close to magnetic fields such as those produced by magnets or loudspeakers. Also, do not place devices that may be sensitive to magnetic forces (such as a wrist watch or a credit card) near the hard disk.
- Do not put heavy objects on the hard disk.
- When handling the hard disk, hold it only by the edges or metal frame.
- The hard disk is sensitive to static electricity. Ensure that proper handling methods are used when installing the hard disk.
- Store in a cool, dry location.

Replacing the hard disk

⚠ Caution

For safety reasons, be sure to turn off and unplug the system before attempting to replace the hard disk.

When replacing the hard disk, follow the procedure below to remove the metal frame.

- 1 Using a crosshead screwdriver, remove the screws (4 places).

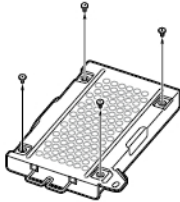

- 2 Hold the hard disk by the edges, and then turn it over.

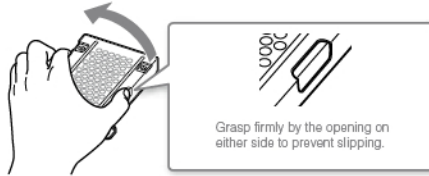

- 3 Remove the hard disk from the metal frame.

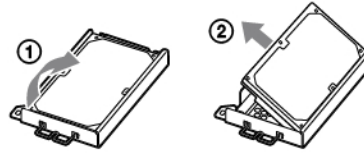

- 4 Place the replacement hard disk on the metal frame for the PS3™ system's hard disk, and then attach using the screws (4 places).

Do not overtighten the screws.

- 5 Install the hard disk in the system.

Refer to the instructions in "Removing the hard disk" (→ page 37) and follow the steps in reverse order when installing. Be sure to fully insert the hard disk in the HDD bay.

- 6 Reinstall the system software.

After the hard disk has been replaced, the system software must be reinstalled (→ page 40).

Replacement hard disks

You can use hard disks of the following types with the PS3™ system.

Size	2.5 inch (internal type) **
Interface format	Serial ATA **

**1 Proper operation is not guaranteed for all models.

**2 Parallel ATA is not supported.

Reinstalling the system software

If the system software does not start when the system is turned on (such as when the hard disk has been replaced), a screen such as the one shown below is displayed. In this case, you must reinstall the system software using downloaded update data.

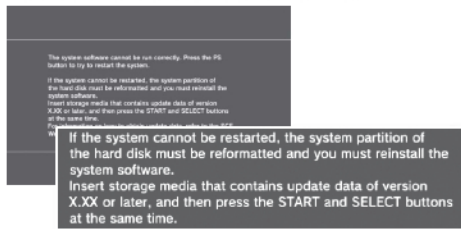

Downloading system software update data

Using a PC with Internet access, download the system software update data from the website shown below. Follow the instructions available on the website to copy the update data from the PC to storage media.

www.us.playstation.com/ps3

Hints

- Use the latest version of the update data available on the website. You cannot reinstall the system software using a version that is earlier than the system software version that had previously been used. If the appropriate update data for your system is not available at the website, contact SCEA Consumer Services (→ back cover).

- If you have a game disc or other disc that contains update data, you may be able to use that disc to reinstall the system software. If you insert the disc in the PS3™ system and follow the on-screen instructions, you can verify whether the update data can be used.
- For additional information on the installation of the system software, refer to the section "Update using a PC" at our website: www.us.playstation.com/ps3.
- The system software included within this product is subject to a limited license from Sony Computer Entertainment Inc. Refer to <http://www.scei.co.jp/ps3-eula> for further details.

Installing the system software

Turn on the PS3™ system, and then insert the storage media containing the update data. Follow the on-screen instructions to reinstall the system software.



Notices

- Do not turn off the system or remove the storage media during the installation. If the installation is cancelled before completion, the system software may become damaged, and the system may require servicing or exchange.
- During the installation, the power button on the system and the PS button on the wireless controller are not active.

Restoring data that has been backed up

You can restore data that you backed up using either of the following methods.

Restoring data in a single operation

You can restore data that you backed up in a single operation by selecting  (Settings) →  (System Settings) → [Backup Utility]. Connect the USB mass storage device that contains the backup data, and then follow the on-screen instructions to perform this operation.

Hints

- You may not be able to use the backup utility to restore some data.
- For details on the backup utility feature, refer to the online user's guide (<http://manuals.playstation.net/document/>).

Restoring selected data



You can manually restore files using the options menu for the file. Connect the USB mass storage device that contains the file, select the file that you want to restore, and then press the  button. Select [Copy] or [Move] from the options menu.

Hint

Some data cannot be copied, moved or backed up.

Transferring data to another PS3™ system / restoring the system

Transferring data to another PS3™ system

You can transfer data that is saved on the hard disk of one PS3™ system (the source system) to the hard disk of another PS3™ system (the destination system) by selecting  (Settings) →  (System Settings) → [Data Transfer Utility].

Notice



When you perform this operation, all of the data that is stored on the PS3™ system that will receive the data (the destination system) will be deleted. For details on how to use the utility and its limitations, refer to the online user's guide (<http://manuals.playstation.net/document/>).

Restoring the PS3™ system

Notices



- If you restore the default settings or restore the PS3™ system, changes to the settings cannot be undone. Data loss or corruption is the responsibility of the user.
- Do not turn off the PS3™ system during this operation. If the operation is cancelled before completion, the system software may become damaged, and the system may require servicing or exchange.
- During this operation, the power button on the system and the PS button on the wireless controller are not active.
- You cannot use this feature to go back to an earlier version of the system software.

Restoring default settings

You can restore from the current settings under  (Settings) to the default settings by selecting  (Settings) →  (System Settings) → [Restore Default Settings].

After you complete the operation and restart the system, the initial setup screen will be displayed. Follow the on-screen instructions to perform initial setup of the system software (→ page 15).



Deleting data on the hard disk drive

You can delete all data on the system's hard disk and restore from the current settings under  (Settings) to the default settings by selecting  (Settings) →  (System Settings) → [Restore PS3™ System].

You can shorten the time required to perform this operation by selecting [Quick Format] from the list of hard disk format options. It is recommended that you select [Full Format] when formatting a hard disk that contains important or sensitive data.

After you complete the operation and restart the system, the initial setup screen will be displayed. Follow the on-screen instructions to perform initial setup of the system software (→ page 15).

Before disposing of or transferring the PS3™ system

Before disposing of the system, it is recommended that personal information and other data of similar nature be deleted. To delete data, go to  (Settings) →  (System Settings) → [Restore PS3™ System].

It is recommended that you select [Full Format] when the screen for selecting a hard disk format method is displayed during system restoration. Although formatting time can be reduced by using [Quick Format], it might be possible to restore erased data in some cases if a special tool is used.

Before requesting service

Go through this section if you experience difficulty in operating the PS3™ system. Should any problem persist, contact Consumer Services (→ back cover) for assistance.

Power

The system does not turn on.

- Check that the AC power cord is securely inserted in the system and the electrical outlet.

When the power button is pressed, the system beeps repeatedly and then the power indicator will turn off.

- The temperature inside the system is becoming too high. Check whether the system is being used in a location that is too warm. Ensure that vents are not blocked and that there is adequate airflow around the system. Press the power button. (The power indicator will become solid red.) Wait a while, and then turn on the system again.

Picture

There is no picture on the TV screen.



- Check that the cable is securely inserted. Try disconnecting the cable from the PS3™ system or TV and then reconnecting it.
- There may be a problem with the AV cable in use. Try using another cable that is compatible with the PS3™ system.
- Adjust the video input on the TV to match the input connector that is being used to connect to the PS3™ system.

- The BD may be disc-locked. Enter the password that was set when the disc was created.
- See also the notices under "Playable discs" (→ page 49).

Certain BDs cannot be played.

- To play commercially available BD video software, the encryption key for AACs (Advanced Access Control System) may need to be renewed. To renew the key, you must update the system software.

The size of the video image and the TV screen do not match.

- The settings of the connected TV and the video output settings of the system may not match. Check the following items:
 - Check that the system's settings under  (Settings) →  (Display Settings) → [Video Output Settings] are correct.
 - Check that the settings of the connected TV are correct. For details, refer to the instructions supplied with your TV.
- With some video content, the screen size cannot be changed.

The screen color does not seem right.

- If set to the default setting, the background color changes as the time, day and month changes.

Audio

There is no sound.



- Check that the muting function on the TV or speakers is turned off. Also check that the volume is at the appropriate level.
- If an audio device is connected, check the settings of the device. For details, refer to the instructions supplied with the audio device.
- There may be a problem with the AV cable. Try using another cable that is compatible with the PS3™ system.



- If the video output settings on the system do not match those of the cable or TV in use, there may be no picture. If the screen goes blank, turn off the system. Then, with only the system and the TV connected, press the system's power button for more than 5 seconds to turn the system back on. The video output settings will automatically be reset to the standard definition (SD) resolution.

The picture is distorted.

- Check that the cable is securely inserted. Try disconnecting the cable from the PS3™ system or TV and then reconnecting it.

The Blu-ray Disc (BD) or DVD cannot be played, or the picture is distorted.

- When outputting DVD content or PlayStation3 format software in standard definition (SD) resolution, only discs recorded in the NTSC standard can be played.
- If the system is connected to a VCR, copy protection encoding on some BDs and DVDs may cause image distortion, or may cause the image to become lighter or darker. In such cases, connect the system to the TV directly. You may also see a similar occurrence if using a combination TV/VCR unit.
- If the BD or DVD does not match the region code set in the system, it cannot be played. For details, see "Region codes" (→ page 50).
- Some DVDs are preset with parental control restrictions. Enter the password that was set in  (Security Settings) to temporarily increase the parental control level.
- If you record video content on DVD-R, DVD-RW, DVD+R or DVD+RW media using a device such as a DVD recorder, you must finalize the media before playing it on the PS3™ system. Finalize the media using the recording device.
- Some BDs are preset with parental control restrictions. Enter the password that was set in  (Security Settings) to change the parental control level.

- Some software do not support digital audio output.
- If the system's audio output settings do not match the AV cable or device in use, the system may not produce sound. Check that the system's settings under  (Settings) →  (Sound Settings) → [Audio Output Settings] are correct.
- Some content that support Dolby Digital, DTS, and other formats may not produce audio from all channels.

Music files do not play.



- Playback methods may be limited for some music files that are distributed via the Internet. In such cases, it may not be possible to play the content on the PS3™ system.

Network

A connection to the network cannot be established.

- If using a wired connection, check that the Ethernet cable is securely connected.
- Check that the network settings are correct. Refer to the instructions supplied by your Internet service provider or in the software manual to make the correct network settings.

The message [An error occurred during communication with the server. This is a DNS error. (80710102)] is displayed during the Internet connection test.

- If you connect the system to a modem that does not have a router feature (bridge modem), you may need to set PPPoE settings. Select  (Settings) →  (Network Settings) → [Internet Connection Settings] → [Custom] to start configuring the Internet connection. Continue adjusting settings until you see the IP address setting screen. Select [PPPoE], and then enter the user name and password provided by your Internet service provider.

- If you connect your system to a router, complete initial settings on the router first. After completing the settings on the router, try to adjust the network settings again by selecting **Settings** → **Network Settings** → **Internet Connection Settings** → **[Easy]** again. For details about the router settings, refer to the instructions supplied with your router.

The message [The attempt to obtain an IP address timed out.] is displayed during the Internet connection test.

- If you disconnected the Ethernet cable that is used to connect to a device such as a PC, and then reconnected it to the system, you must restart both your system and the modem. After restarting both devices, update your network settings by selecting **Settings** → **Network Settings** → **Internet Connection Settings** → **[Easy]**. For details about restarting your modem, refer to the instructions supplied with your modem.
- If you are using a wireless connection, the WEP key may be wrong. Check that you have the correct WEP key, and then enter it again.

The message [The PPPoE user name or password is not correct.] is displayed during the Internet connection test.

- Enter the correct user name and password for PPPoE. If you do not know the user name and password, contact your Internet service provider.

The Web page does not display properly.

- Certain content, such as content that requires specialized software, may not display properly on some Web pages.

Disc Media and USB Devices

The system does not recognize the disc.

- Remove the disc and reinsert it.

- If the disc has a label, insert it with the label side up.
- Check whether the disc is scratched or dirty. If dirty, wipe it gently with a soft cloth.
- See also the notices under "Playable discs" (→page 49).

The disc cannot be removed.

- Press the eject button for 10 seconds or longer to force the disc to eject. After removing and before reinserting a disc into the system, turn off the system, and then turn on the system again to resume use.

The system does not recognize the USB device, or the USB device does not operate properly.

- Check that the device is inserted correctly.
- The connected device may not be usable with the system.
- Try using a different USB connector on the PS3™ system. The device may not be recognized depending on the combination of USB connectors in use.
- In some cases, the system may not recognize the device if an external USB hub is used and more than the allotted number of devices are connected. Try removing unused devices.

When connecting a USB device, the message [An unknown USB device has been connected.] is displayed.

- The connected device may not be compatible with the system or software application.
- The device may be compatible with specific software only. Use software that is compatible with the device.
- There may be too many USB hubs connected. Try removing a USB hub.

Wireless controller

The wireless controller does not function.

- When using the wireless controller, you must pair it with the system and assign a controller number. With the system turned on (power indicator is lit solid green), connect the system and the controller using the USB cable, and then press the PS button on the controller.
- The controller number may have been cleared. Press the PS button on the controller to reassign the number.
- With some software, you may need to use a specified controller number. Refer to the manual for the software in use.
- Check the charge level of the wireless controller battery. When the controller is used in wireless mode, it will not function if the battery does not have any charge left. Charge the battery by connecting the controller to the system with the USB cable.
- If you cannot use the controller even after checking the items above, try resetting the wireless controller by pushing the reset button on the controller rear with a thin-tipped object such as a pen.



The wireless controller operates in an abnormal manner.

- Try resetting the wireless controller by pushing the reset button on the controller rear with a thin-tipped object such as a pen.

The wireless controller does not vibrate.

- Check that you are using a DUALSHOCK®3 Wireless Controller. The SIXAXIS® Wireless Controller does not vibrate.

- Try selecting **Settings** → **Accessory Settings** → **[Controller Vibration Function]**, and then setting **[Vibration Function]** to **[On]**.
- The software may not support the vibration function. Refer to the instruction manual for the software. For software downloaded from **PlayStation Store**, refer to the compatibility notice information included in the software's online description.

The response to button operations is slow.

- The response speed may be slow on an LCD display or PC display. This is not a malfunction.

The battery does not charge or does not fully recharge.

- The battery can only be charged when the system is turned on. (The power indicator on the system front is lit solid green.)
- See "Wireless controller battery" (→ page 51).

The battery charge does not last long.

- The battery may be wearing out. Battery charge duration will gradually decrease with repeated usage and age. See "Wireless controller battery" (→ page 51).

Even when the wireless controller is not being used, it loses its charge over time.



- The controller's battery slowly loses its charge even when the controller is not in use. It is recommended that you charge the controller frequently.

Other issues

The system makes noise.

- ➔ When using the system in a location where heat can build up, such as in an enclosed AV cabinet, on carpet or a cushion, or near a wall (within 10cm of the wall), the internal fan will rotate rapidly to reduce the system's temperature and this may generate increased noise. Move the system to a location with good ventilation.
- ➔ Depending on how a disc is being used, such as when copying an audio CD to the hard disk or starting software from a disc, disc noise may be louder than normal. Furthermore, some software may cause more disc noise than others.



You forgot your password for security settings.

- ➔ If you restore the system using  (Settings) ➔  (System Settings) ➔ [Restore Default Settings], your password will return to "0000". However, note that all settings other than the password will also be reset. Once these settings are reset, they cannot be recovered.

The system is warm.

- ➔ When the system is being used or is turned on, it may become warm. This is not a malfunction.

The screen freezes during gameplay.

- ➔ Check whether the disc is scratched or dirty. If dirty, wipe it gently with a soft cloth.
- ➔ If you have game data for PlayStation®3 format software installed, try deleting the game data and reinstalling the software. Select  (Game) ➔  (Game Data Utility), press the (X) button, and then delete the game data from the options menu. Next, reinstall the PlayStation®3 format software. Be careful not to delete the saved data for the game.

The screen is frozen. The system does not operate.

- ➔ Disconnect all accessories such as USB devices from the system, and then restart the system. Pressing the power button for 15 seconds or longer will force the system to turn off (enter standby mode). After the system turns off, turn it on again.

The power indicator is flashing red and green alternately.

- ➔ The interior of the system may have become too warm. This is typically due to the operating environment. Check whether the system is being used in a warm location. Ensure that vents are not blocked and that adequate airflow exists around the system. Continuing to use the system in the above condition will cause it to stop functioning. Turn the system off and leave it unused until it cools down. After the system cools down, turn it on again.

The system does not recognize content.

- ➔ The content may be of a format that is not supported by the system. Content of types not supported by the system will not be recognized. For information on supported formats, refer to the online user's guide (<http://manuals.playstation.net/document/>).

Specifications

Design and specifications are subject to change without notice. Information about system functionality and images published in this document may vary from those for your PS3™ system, depending on the system software version in use.

PlayStation®3 system

CPU		Cell Broadband Engine™
GPU		RSX™
Audio output		LPCM 7.1ch, Dolby Digital, Dolby Digital Plus, Dolby TrueHD, DTS, DTS-HD, AAC
Memory		256 MB XDR Main RAM, 256 MB GDDR3 VRAM
Hard disk	2.5" Serial ATA	320 GB**2
Inputs/ outputs*3	Hi-Speed USB (USB 2.0)	2
Networking		Ethernet (10BASE-T, 100BASE-TX, 1000BASE-T) × 1 IEEE 802.11 b/g Bluetooth® 2.0 (EDR)
Controller		Wireless Controller (Bluetooth®)
AV output	Resolution	1080p, 1080i, 720p, 480p, 480i
	HDMI OUT connector*4	1
	AV MULTI OUT connector	1
	Digital out (optical) connector	1
BD/DVD/ CD drive (read only)	Maximum read rate	BD × 2 (BD-ROM) DVD × 8 (DVD-ROM) CD × 24 (CD-ROM)

Laser	Type: Semiconductor, continuous BD Wavelength: 400 - 410 nm Power: Max. 17.5 mW DVD Wavelength: 655 - 664 nm Power: Max. 2.6 mW CD Wavelength: 770 - 800 nm Power: Max. 4.0 mW
Power	120 V AC, 60 Hz
Power consumption	Approx. 230 W
External dimensions (excluding maximum projecting part)	Approx. 290 × 65 × 290 mm (11.5 × 2.6 × 11.5 in) (width × height × length)
Mass	Approx. 3.0 kg (6.6 lb)
Operating temperature	5°C - 35°C (41°F - 95°F)

*1 Hard disk capacity calculated using base 10 mathematics (1GB = 1,000,000,000 bytes). The system software for this PS3™ system calculates capacity using binary mathematics (1GB = 1,073,741,824 bytes) and consequently displays lower capacity and free space. The difference in displayed values does not indicate a difference in the actual number of bytes.

*2 A portion of the hard disk capacity is reserved for use in connection with system administration, maintenance, and additional options. This may occur upon installation of system software or other software. As a result, the availability of hard disk capacity may vary depending on the system, system software version, or available options, and is not otherwise available for your use.

*3 Functionality of all connected devices is not guaranteed.

*4 "3D", "Deep Color", "x.v.Color" and "HD lossless audio format" are supported.

DUALSHOCK®3 Wireless Controller

Battery type	Built-in rechargeable Lithium-Ion battery
Voltage	DC 3.7 V
Battery capacity	610 mAh
Mass	Approx. 180 g (6.4 oz)

Supplied AV cable and USB cable

AV cable	Company:	SONY
	Part No.:	1-838-149-11
USB cable	Company:	SONY
	Part No.:	1-833-625-12

BRAVIA™ Sync



"BRAVIA™ Sync" is a Sony product feature that allows you to use the remote controls of BRAVIA™ televisions (Sony Corporation products) to operate various devices that are connected to each other through HDMI cables. BRAVIA™ Sync uses the control signals that are transferred through the HDMI connections.

To enable the BRAVIA™ Sync feature, go to (Settings) (System Settings) [Control for HDMI], and set the option to [On]. For details, refer to the online user's guide (<http://manuals.playstation.net/document/>) and the instructions supplied with the BRAVIA™ products in use.

Hint

This feature can only be used on devices that support the BRAVIA™ Sync feature. Compatibility with all devices that comply with the HDMI CEC specification is not guaranteed.

Playable discs

For additional information on compatible media types, visit our website at www.us.playstation.com.

Blu-ray Disc (BD)	PlayStation®3 format BD-ROM
	BD-ROM
	BD-R
	BD-RE*1
DVD	DVD-ROM
	DVD+R/RW
	DVD-R/RW
	AVCHD
	DSD Disc
CD	PlayStation® format CD-ROM*2
	CD-DA (audio CD)*3
	CD-R/RW

*1 Playback of BD-RE ver. 1.0 discs is not supported.

*2 This model of the PlayStation®3 system is designed to play PlayStation®3 format software and has limited backward compatibility. This system is not compatible with and will not play PlayStation®2 format software. Some PlayStation® format software may play on this system. For more information, visit www.us.playstation.com.

*3 Playback of Super Audio CDs is not supported.

Region codes

Depending on the disc, a region code that is based on the geographic region where the disc is distributed may be assigned. This system can play discs marked with the following region codes.

Disc	Region code
Blu-ray Disc (BD)	
DVD	
PlayStation®3 format BD-ROM	
PlayStation® format CD-ROM	NTSC U/C

DVD and PlayStation®3 format software

- When outputting DVD content or PlayStation®3 format software in SD resolution, only discs recorded in the NTSC standard can be played.
- When playing PlayStation®3 format software in HD resolution, a TV that supports video playback at 59.94 Hz is required.

DVD-R/DVD-RW/DVD+R/DVD+RW discs

Discs that have not been finalized cannot be played.

Notices

- Use only circular-shaped discs with the system. Do not use irregularly-shaped discs (for example, heart- or star-shaped discs). Using irregularly-shaped discs may cause a malfunction.
- Do not use damaged, re-shaped or repaired discs. Use of such discs may cause a malfunction.

- When using an 8 cm disc, insert the disc in the system without an adaptor.
- The audio CD playback feature of this system is designed to conform to the Compact Disc (CD) standard. Recently, some record companies have started marketing music discs encoded with copyright protection technologies. Some of these music discs do not conform to the CD standard and may not be playable on this system.

- A DualDisc is a dual-sided disc that combines a DVD side and an audio side. Note that the audio side is not guaranteed to play because this type of disc does not conform to the specifications required for an audio Compact Disc (CD).

- If a device that is not compatible with the HDCP (High-bandwidth Digital Content Protection) standard is connected to the system using an HDMI cable, video or audio cannot be output from the system.

- Copyright-protected Blu-ray video discs can only be output at 1080p using an HDMI cable connected to a device that is compatible with the HDCP (High-bandwidth Digital Content Protection) standard.

- When you use the AV MULTI OUT connector of the system to connect to a TV, the resolution used to output copyright-protected video from a BD or from video files may be limited or the video may not be output.

- When playing discs with content that was copied fraudulently, abnormal sounds may be produced or the content may not play correctly.

- To enjoy continuous playback of copyright-protected BDs, the encryption key for AACS (Advanced Access Control System) may need to be renewed. To renew the key, you must update the system software.

- Some discs may not be playable due to scratches, dust, the quality of recording, or the characteristics of the recording device.

- In rare instances, CDs, DVDs, BDs and other media may not operate properly when played on the PS3™ system. This is primarily due to variations in the manufacturing process or encoding of the software.

Wireless controller battery

⚠ Caution

- If you come into contact with material from a leaking battery, take the following actions:
 - If the material gets into the eyes, do not rub. Immediately flush the eyes with clean water and seek medical attention.
 - If the material comes into contact with the skin or clothes, immediately rinse the affected area with clean water. Consult your physician if inflammation or soreness develops.
- Do not allow the battery to come into contact with fire or subject it to extreme temperatures such as in direct sunlight, in a vehicle exposed to the sun or near a heat source.

Wireless controller battery life

- The battery has a limited lifespan. Battery duration will gradually decrease with repeated usage and age.
- Battery life also varies depending on the storage method, usage state, environment and other factors.

Storage

When the wireless controller is not used for an extended period of time, it is recommended that you fully charge it at least once a year in order to maintain battery functionality.

When disposing of the wireless controller

The lithium-ion battery of the wireless controller is recyclable. When disposing of the wireless controller, remove the battery and follow local regulations regarding disposing of batteries.

Removing the battery

⚠ Caution

- Remove the battery in a location out of the reach of small children to help prevent accidental swallowing of small parts such as the screws.
- Be careful not to hurt your nails or fingers when removing the controller casing.
- For safety reasons, attach tape or a seal on the metal part of the battery before disposing.

Notice

Other than when disposing of the wireless controller, never remove the screws and never remove the battery from the wireless controller.

1 Disconnect the USB cable from the wireless controller.

2 Using a crosshead screwdriver, remove the screws (5 places).



3 Remove the casing.

- ① Push in the direction of the arrow.
- ② Pull the casing apart.

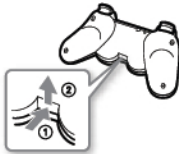

4 After disconnecting the connector, remove the battery.



Recycling Lithium-Ion Batteries

Lithium-Ion batteries are recyclable. You can help preserve our environment by returning your used rechargeable batteries to the collection and recycling location nearest you.



For more information regarding recycling of rechargeable batteries, call toll free 1-800-822-8837, or visit <http://www.rbrc.org/>

⚠ Caution

Do not handle damaged or leaking Lithium-Ion batteries.